

Stock Code: **50080-BRZ/OPL**

Collection: Conga

PRODUCT INFORMATION

Base: 50080 Parent: 50080
Mounting Type: Ceiling UPC: 641594079715
Finish: Bronze
Diffuser: Opal

PRODUCT MEASUREMENTS

FIXTURE	BACKPLATE / CANOPY
Length:	Length
Width:	Width:
Diameter 16"	Diameter:
Height: 4.5"	Height:
Extension:	
Overall Height:	

TECHNICAL SPECIFICATIONS

SPECIFICATIONS

Frame Material: Metal	
Diffuser Material: Glass	
Lamping Type: E-26 (Incandescent)	Jbox: Standard
Lamping Base: E-26	Lamp Wattage: 75 W
Lamp Quantity: 2	Total Wattage: 150 W
Voltage: 120v	Lamps Included: No

QUALIFICATIONS

Location Rating Damp	
Certification: ETL (US/Canada) Listed	
ADA Compliant: No	Energy Star: No
JA8 Compliant: No	Emergency Lighting: No
Marine Grade: No	Warranty: 1 Year

PHOTOMETRICS

Dimmable: Yes	Nominal Lumens N/A
CRI: N/A	Delivered Lumens: N/A
CCT: N/A	
Recommended Dimmers: (TRIAC)Any Standard Dimmer	

Additional Notes:
Custom Finish 5 Piece Minimum Order Quantity

Project Name: _____
 Location: _____
 Type: _____
 Quantity: _____
 Notes: _____



LINE DRAWING

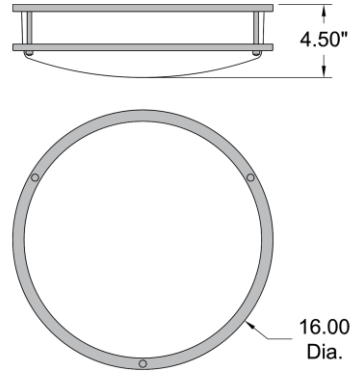

IES FILE

In addition to Access Lighting's purchase and warranty terms and conditions, by signing below or placing an order, you agree that you are authorized to bind the entity placing any order and acknowledge the following: All of sizes and measurements are approximate and all images are for illustrative purposes only. In the event of an inconsistency, the "Product Measurements" section controls. There also may be slight differences in the colors and designs compared to the displayed and printed images.

Signature: _____

Print Name _____ Date: _____

Toll Free 800-828-5483 www.AccessLighting.com

14410 Myford Road, Irvine, CA 92606

